

# Data Sheet



Article number: 433000080

Description: Rota-fix shaft-hub connection C 80x91

Note: Not self centering. Small radial dimensions

## Measures

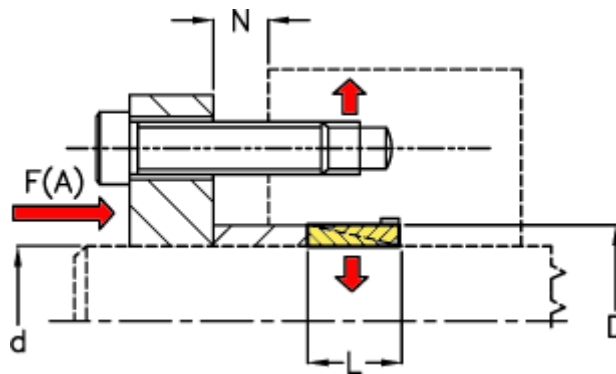

d mm = 80

D mm = 91

F(A) kN = 300

Fit tolerance = Aksel  $\varnothing$  ? 38 h6, Aksel  $\varnothing$  > 38 h8, Nav  $\varnothing$  ? 38 H7, Nav >  $\varnothing$  38 H8

F kN torque = 54.0

L = 17

N1 = 5

N2 = 6

N3

N4

P N/mm<sup>2</sup> surface press

Surface roughness

T N m torque